



ÉCLATANT

SIÈGE NESTLÉ

Suisse









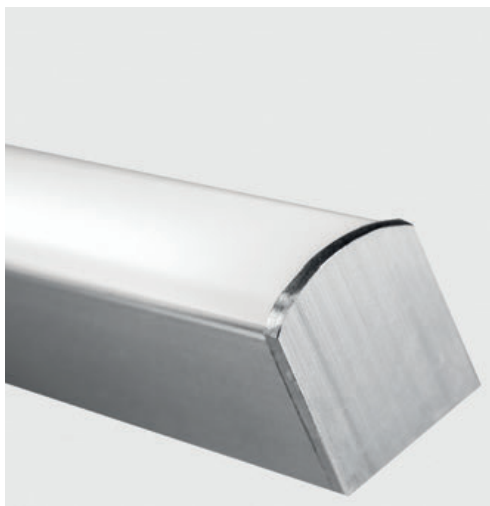



Ce profil offre une mise en œuvre sans limite dans la composition de formes et de graphismes lumineux. Dans ce projet, le Horus est intégré dans un plafond tendu.

HOMOGENE @@@

horus

Ce produit est idéal pour obtenir un effet homogène parfait avec des dimensions réduites. Le capot diffusant a été spécialement développé pour obtenir des couleurs éclatantes.



- 
  +
 
  +
 
-  Blancs : 2 400° K à 6 000° K, Blanc malin, RVB, RVBW
-  24 V  
-  2 m
Réalisation de longueurs sur-mesure à la demande
-  44 ou 65  10
-  IRC > 90 disponible dans notre gamme UL et XT
-  < 3 ellipses de McAdam

	ÉLÉMENT LUMINEUX	IP	TYPE DIODES	NB. DIODES/M	FLUX DU LUMINAIRE	PUISSANCE/M	PAS DE COUPE
horus	horus-lf	44	led SMD 3528	60	230 lm/m	5 W	10 cm
	horus-hl	44	led SMD 5050	56	730 lm/m	12 W	12,5 cm
	horus-hl-ip	65	led SMD 5050	56	730 lm/m	12 W	12,5 cm
	horus-ul	44	led SMD 3528	240	920 lm/m	20 W	2,5 cm

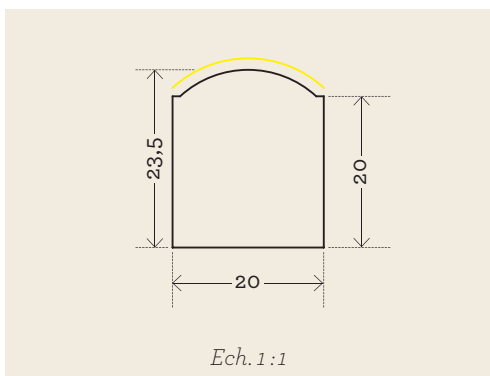

EN COMPLÉMENT

- Finition embouts en aluminium
- Gradation possible en DALI, 0-10 V, DMX, KNX, PWM, bouton poussoir